

Operating Instructions

Dishwasher

GV67260

gorenje

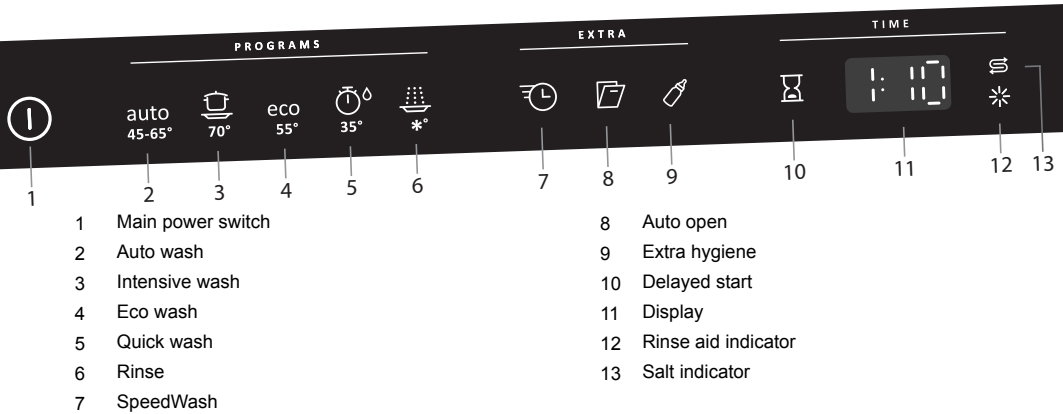

Safety instructions	2
Before washing for the first time	3
Loading the dishwasher	4
Using the dishwasher	5
Settings	9
Care and cleaning	11
Troubleshooting	13
Installation	17
Service	18
Information for test institute	19
Technical information	20

Safety instructions

General

- Read the operating instructions and keep them in a safe place!
- Never use the dishwasher for any purpose other than that specified in these operating instructions.
- Do not load the dishwasher door or dishwasher baskets with anything other than dishes.
- Never leave the dishwasher door open as someone may trip on it.
- Use only dishwasher detergent!
- This machine can be used by children aged 8 and upwards, and by people with reduced physical capacity, mental ability, memory loss or lacking experience and knowledge. These individuals must be supervised when using the machine or have instructions on how to use the machine and understand the risks that can occur. Cleaning of the machine must not be carried out by children without supervision.
- Children must be watched to ensure they do not play with the dishwasher.
- Damaged mains cables must only be replaced by a qualified electrician.
- Only use the dishwasher in household-type environments for dishwashing household dishes. All other use is prohibited.
- Never place dishes with solvent residues in the dishwasher due to the risk of explosion. Nor may dishes that contain ash, wax or lubricants be washed in the dishwasher.

WARNING!

Knives and other pointed items must be placed horizontally in the dishwasher's special cutlery baskets.

Installation

See the section Installation.

Child safety

- Always start the dishwasher immediately after adding detergent.
- Keep children away from the dishwasher when the door is open. Some detergent may remain inside!
- Do not allow children to use or play with the dishwasher. Be especially vigilant when the door is open.

WARNING!

Children must be supervised – dishwasher detergent is corrosive!

Winter storage/transport

- Store the dishwasher where the temperature remains above freezing.
- Avoid long transport distances in very cold weather.
- Before transporting a used dishwasher all water must be pumped from the machine. Run the Rinse programme.
- Transport the dishwasher upright or laying on its back.

Overflow guard function

The overflow protection starts pumping out the machine and turns off the water supply if the water level in the dishwasher exceeds the normal level. If the overflow protection is triggered, turn off the water supply and call the service department.

Packing material

Please sort waste materials in accordance with local guidelines.

Disposal

- When the dishwasher has reached the end of its service life and is to be disposed of, it should immediately be made unusable. Pull out the power cable and cut it as short as possible.
- The dishwasher is manufactured and labelled for recycling.
- Contact your local authority for information about where and how your dishwasher should be correctly recycled.

Before washing for the first time

The water softener

In order to achieve good dishwashing results, the dishwasher needs soft water (water with low mineral content). Hard water leaves a white coating on dishes and the dishwasher.

Water hardness is specified using the following scales: The German water hardness scale (°dH) and the French water hardness scale (°fH). A water supply with a water hardness in excess of 6°dH (9°fH) must be softened. This is done automatically with the aid of the built-in water softener. In order for the softener to function optimally, it must be adjusted to the hardness of the water supply.

Contact the local waterworks to check the water hardness in your area.

Adjusting the water softener

Chapter Settings on page 9 describes how to adjust the water softener.

Fill up the salt

Before you begin using a dishwasher with a water softener, you must fill the salt compartment with salt for the water supply to be softened automatically. Use large grain salt or special dishwasher salt.

WARNING!

In order to avoid rust stains a dishwashing programme must be started immediately after adding salt.

Never pour dishwasher detergent into the salt compartment. This destroys the water softener!

Do as follows the first time:

- 1 Unscrew the lid as illustrated.
- 2 Place the funnel supplied with the dishwasher in the salt compartment top-up hole. First, pour in about 1 l of water.
- 3 Then add salt, a maximum of 1.5 kg, until the compartment is full.
- 4 Wipe up any excess salt so that the lid can be screwed on firmly.
- 5 Run a programme to ensure that any salt in the dishwasher is rinsed away.

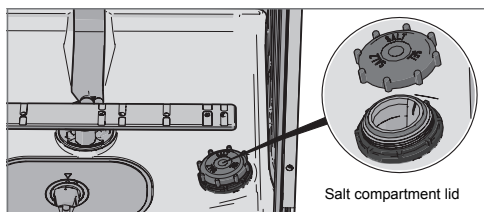

Refill salt indicator

When the salt needs topping up, the above symbol lights on the display.

When the salt runs out, unscrew the cap and fill the container with salt. Water is only needed the first time! Wipe clean and tighten. Run a programme to ensure that any salt in the dishwasher is rinsed away.

After topping up, it may take a while before the symbol goes out.

Top up with rinse aid

Drying is faster and a better result is achieved if you use rinse aid. You will also achieve a better dishwashing result with clear and spotless dishes.

- 1 Open the rinse aid compartment lid.
- 2 Carefully top up with rinse aid. Only add rinse aid to the level marked **max**.
- 3 Wipe up any splashes of rinse aid around the compartment.
- 4 Close the lid firmly.

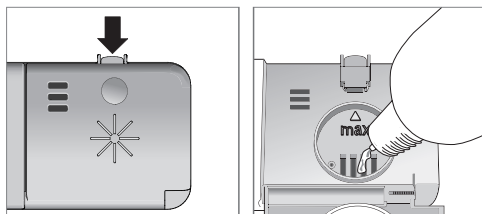

Refill rinse aid indicator

When the rinse aid needs topping up, the above symbol lights on the display.

After topping up, it may take a while before the symbol goes out.

Setting the rinse aid dosage

The section Settings describes how to set the rinse aid dosage. Rinse aid dispensing can be set from 0 (Off) to 5 (High dose). (Factory settings: 5)

Increase the rinse aid dosage:

- If the dishes have water marks.

Decrease the rinse aid dosage:

- If the dishes have a sticky white/blue film.
- If the dishes are streaked.
- Build-up of foam. If you have very soft water, the rinse aid can be diluted 50:50 with water.

Loading the dishwasher

Economic dishwashing

- Do not start the dishwasher until it is fully loaded to save energy.
- Do not rinse under running water. Simply scrape off large food particles before loading the dishwasher.
- Choose an environmentally-friendly detergent. Read the environmental declaration on the packaging!
- If the dishes are only slightly dirty, you can select a programme with a low temperature.
- Better drying results are achieved if you use the Auto open option, which automatically opens the dishwasher door once the programme has ended.

Fragile dishes

Some cookware is not dishwasher safe. This can be for several reasons. Some materials cannot withstand strong heat, others can be damaged by dishwashing detergent.

The dishwasher's baskets

The dishwasher is equipped with a top cutlery tray, an upper basket and a lower basket.

Top cutlery tray

The top cutlery tray has space for cutlery, ladles, whisks, serving cutlery and similar items.

shelf and knives are placed in the knife stand on the right (if fitted).

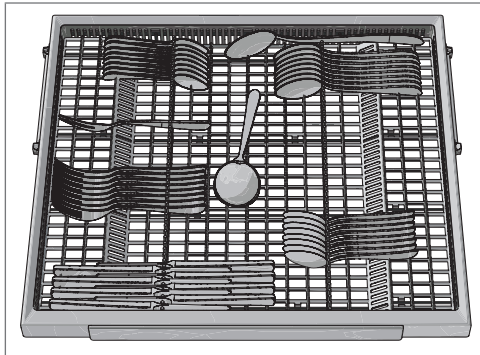
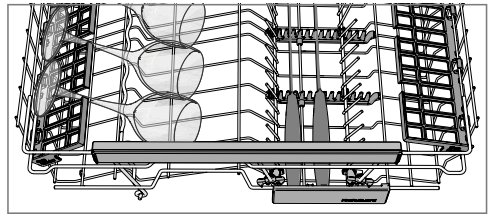
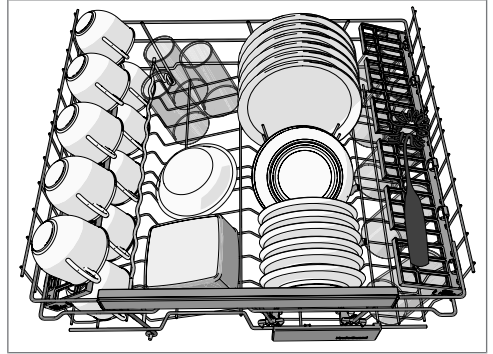

Upper basket

Place glasses, cups, bowls, side plates and saucers in the upper basket. All dirty surfaces should face inwards and downwards! Wine glasses are placed on the wine glass

Raising and lowering the upper basket

- 1 Pull out the upper basket.
- 2 Grab the sides of the upper basket with both hands and lift it up.
- 3 Repeatedly lift the basket with both hands to change its position. (The upper basket can be set in three positions.) When the upper basket is in the highest position lifting it will return it to the lowest position. Note that both sides of the basket must always be set to the same height.

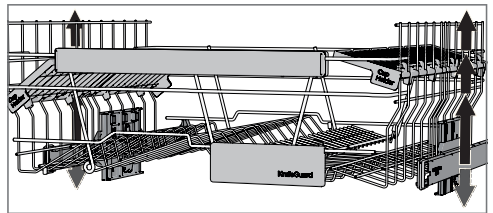

Foldable tines

The foldable tines can be folded up or down to make it easier to load pots, bowls and glasses. Release the foldable tines by pressing the catch inwards before adjusting their position.

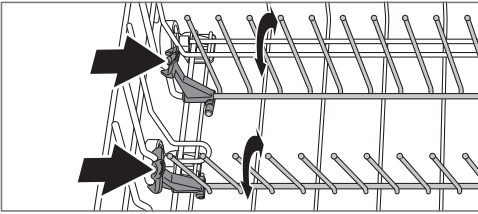

Lower basket

Place plates, side plates, serving dishes and pots in the lower basket.

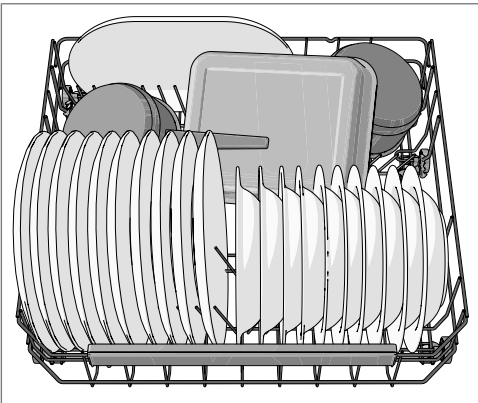

Foldable tines

Fold down the foldable tines (plate supports) when dishwashing pots. Release the foldable tines by pressing the catch inwards before adjusting their position.

NOTE!

Place the dishes in the machine so that the rinse water will run off them; this is especially important for plastic.

Check that the spray arms can rotate freely.

Add detergent

Add the detergent to the detergent compartment. There is a compartment for the prewash and one for the main wash. If powder and liquid dishwasher detergents are used, add a small amount of the detergent to the prewash compartment. Contact the detergent manufacturer if you have questions about the detergent.

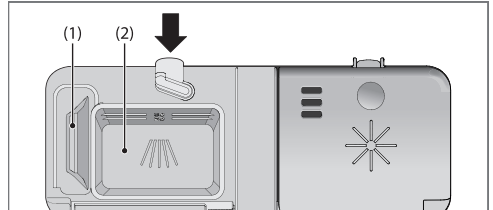

- 1 Prewash detergent compartment
- 2 Main wash detergent compartment

Detergent is added according to water hardness.

Follow the instructions on the detergent packaging. This dishwasher is fitted with a water softener, so use detergent and rinse aid doses suitable for soft water.

Too much detergent can result in less effective dishwashing and also entails greater environmental impact.

NOTE!

Use only dishwasher detergent! Washing up liquid must not be used as the foam that forms prevents the dishwasher from operating effectively.

Dishwasher tablets

Halve the tablet if it is difficult to close the dispenser lid. There is a risk that the detergent will not be released properly if the lid is tight and will not open correctly.

NOTE!

Dishwasher tablets are not recommended for short programmes (less than 75 minutes). Use powder or liquid dishwasher detergent instead.

3-in-1/All-in-one detergent

Read through the directions for these products carefully. If anything is unclear, contact the detergent manufacturer.

Chapter Settings describes how to activate TAB (3-in-1/All-in-one detergent). Note that salt must be put in the salt compartment. If you are not satisfied with the dishwashing or drying results, deactivate the setting TAB (3-in-1/All-in-one detergent) and top up with salt, detergent and rinse aid. See Chapter Before washing for the first time.

The main power switch

Press and hold the main power switch until the display lights up.

PROGRAMS - Choose programme

Press the desired programme until the programme symbol is activated.

auto

45-65° **Auto wash**

The dishwasher can measure how dirty the dishes are and adjust water consumption and temperature accordingly. When newly installed, the programme needs to be run five times before it is fully adapted and can provide the best results.

auto

45-65° **Auto wash** ¹⁾ +  **SpeedWash** +  **Auto open**

An effective programme for daily use for slightly dried leftovers. (This programme is not intended for burnt food, such as on oven dishes.)



70° Intensive wash

Programme for very dirty dishes, such as pans, casserole dishes and oven dishes. If these dishes do not completely fill the dishwasher, you can add plates and the like.

ECO

55° **Eco wash**

This programme is intended for cleaning normally dirty dishes and is the most effective programme in terms of combined energy and water consumption.



35° **Quick wash**

This programme is used for glasses and porcelain that is slightly dirty, such as coffee cups.

In combination with SpeedWash, a shorter programme is achieved (15 minutes).



*° **Rinse**

Used to rinse dishes while you wait for the dishwasher to become fully loaded.

EXTRA - Selecting Options

To select an option, press one of the option buttons until the option is activated. The available options vary between

programmes and some options cannot be combined (available options glow dimly).



SpeedWash

This option shortens the programme time, but uses more energy and water.



Auto open

The dishwasher door opens automatically at the end of the programme, which improves the drying results. (If the dishwasher is built-in the surrounding furnishings must be resistant to any condensation.)

NOTE!

The dishwasher door must not be blocked when set to open automatically. This can disrupt door lock functionality.



Extra hygiene

This option is intended for situations where demands on hygiene are especially high, such as when dishwashing baby bottles and cutting boards. The temperature is increased in both the main wash and the final rinse.



Delayed start

When you select Delayed start the dishwasher will start 1-24 hours after you close the door.

- 1 Press the button once to activate Delayed start. Press the button several times – or hold it in – to set the desired number of hours.
- 2 Close the door and the dishwasher counts down 1 hour at a time and starts after the selected delay.

If you want to cancel the Delayed start option, open the door and press and hold the main power switch until the display turns off.

Start the dishwasher

Close the door to start the dishwasher. If the main power switch is on the dishwasher will start automatically when the door is closed.

TIME - Time remaining

Once you have chosen a programme and options, the time the programme took when last used is displayed.

Status light

The status light on the bottom part of the dishwasher indicates that a programme has started.

Flashing light

This indicates a fault. See further in the section Troubleshooting.

1) This combination (Auto wash + SpeedWash + Auto open) is also known as QuickIntensive (90 minutes).

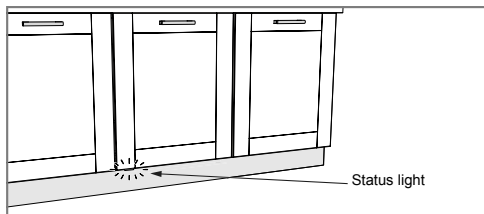

Stopping or changing a programme

If you want to change programme after starting the dishwasher, open the door then press and hold the main power switch until the display turns off. Add more detergent if the lid of the detergent dispenser has opened. Then press the main power switch, choose a new programme and close the door.

Do you want to add more dishes?

Open the door. The dishwasher stops automatically. Add the dishes and close the door. After a while, the dishwasher continues the programme.

How to get the best drying results

- Fully load the dishwasher.
- Place the dishes in the machine so that the rinse water will run off them; this is especially important for plastic.
- Top up with rinse aid or increase the rinse aid dosage level.

- Activate the Auto open option.
- Allow the dishes to cool before unloading the dishwasher.

Once the programme has finished

The end of the programme is indicated by one short signal from the buzzer. The chapter Settings describes how to change this function.

Moreover, the end of the programme is indicated by the status light turning off. See the section Status light in the chapter Using the dishwasher.

The dishwasher switches off automatically after the programme ends. Shut off the water tap after each use.

If the dishwasher is switched off using the main power switch or during a power cut

If the dishwashing programme was not finished, the interrupted programme continues when power is restored.

NOTE!

During drying, the programme is interrupted if the power is cut or the door is open for more than 2 minutes.

Programme chart

PROGRAMS - Program	Detergent, compartment 1 / 2 (ml)	EXTRA - Options	Prewashes	Main wash	Number of rinses	Final rinse	Consumption values ¹⁾		
							Dishwashing time (approx. hrs:min)	Energy (approx. kWh)	Water cons. (L)
Auto wash	--- / 25	Auto open	1-3	50-65 °C	2-3	65 °C	2:10-2:50	0.9-1.5	11-20
Intensive wash	10 / 25		2	70 °C	2	70 °C	2:55	1.7	17
Eco wash ²⁾	--- / 25	Auto open	1	55 °C	2	49 °C	3:00	0.86	6.9
Quick wash	--- / 10			35 °C	1	25 °C	0:20	0.2	10
Rinse	--- / ---				1	--- °C	0:07	0.01	3

1) Consumption values vary depending on the temperature of the incoming water, room temperature, load size, selected additional functions and more.

2) This dishwashing programme is the standard cleaning cycle used to compile the energy labelling information. It is intended for washing normally dirty dishes and is the most effective programme in terms of combined energy and water consumption.

Settings

Open the settings menu:

1. First, open the door. Turn off the machine. Press and hold the main power switch until the display lights up.
2. Within 10 seconds:
 - press the programme button for Auto wash and the option button for SpeedWash.
3. The display shows the settings menu (current setting and its currently set value).
(Exit the menu by browsing through the menu or pressing the main power switch.)

Navigate the settings menu:

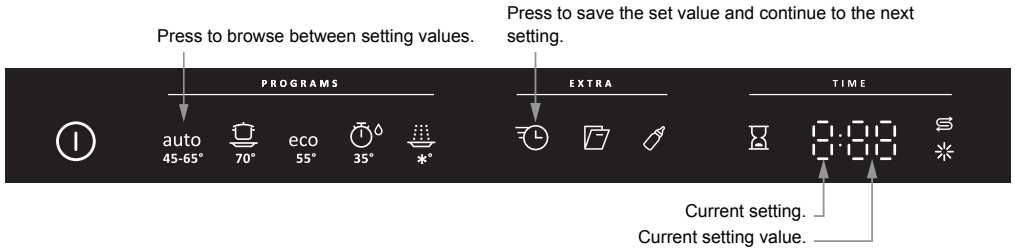

You can now adjust the following settings:

Settings	Options																																					
1. Rinse aid	1:00 - 1:05	Rinse aid dosage setting.																																				
2. Water hardness	2:00 - 2:09	<p>Adjusting the water softener. Read off the appropriate setting from the water hardness table below.</p> <table border="1"> <thead> <tr> <th>°dH</th> <th>°fH</th> <th></th> <th>°dH</th> <th>°fH</th> <th></th> </tr> </thead> <tbody> <tr> <td>0-5</td> <td>0-9</td> <td>2:00</td> <td>20-24</td> <td>35-43</td> <td>2:05</td> </tr> <tr> <td>6-8</td> <td>10-14</td> <td>2:01</td> <td>25-29</td> <td>44-52</td> <td>2:06</td> </tr> <tr> <td>9-11</td> <td>15-20</td> <td>2:02</td> <td>30-39</td> <td>53-70</td> <td>2:07</td> </tr> <tr> <td>12-14</td> <td>21-25</td> <td>2:03</td> <td>40-49</td> <td>71-88</td> <td>2:08</td> </tr> <tr> <td>15-19</td> <td>26-34</td> <td>2:04</td> <td>50+</td> <td>89+</td> <td>2:09</td> </tr> </tbody> </table> <p>Do not forget to put salt in the salt compartment after you have set the water softener to 2:01 - 2:09. For a water supply with a hardness under 6°dH (9°fH), select 2:00. The water softener is deactivated and no salt is needed.</p>	°dH	°fH		°dH	°fH		0-5	0-9	2:00	20-24	35-43	2:05	6-8	10-14	2:01	25-29	44-52	2:06	9-11	15-20	2:02	30-39	53-70	2:07	12-14	21-25	2:03	40-49	71-88	2:08	15-19	26-34	2:04	50+	89+	2:09
°dH	°fH		°dH	°fH																																		
0-5	0-9	2:00	20-24	35-43	2:05																																	
6-8	10-14	2:01	25-29	44-52	2:06																																	
9-11	15-20	2:02	30-39	53-70	2:07																																	
12-14	21-25	2:03	40-49	71-88	2:08																																	
15-19	26-34	2:04	50+	89+	2:09																																	

Settings	Options	
3. TAB (3-in-1/all-in-one detergent)	3:00 (Off) 3:01 (On)	<p>You can activate this setting when using 3-in-1/ All-in-one detergent. The dishwashing programmes automatically adapt to provide the best possible dishwashing and drying results every time. If this setting is activated there is no need to add rinse aid since this option disables rinse aid dispensing. It also reduces the amount of salt added to the water softener. Note that salt must be put in the salt compartment.</p> <div data-bbox="613 368 1057 564" style="border: 1px solid black; padding: 5px;"> <p>NOTE!</p> <p>In order to achieve good dishwashing results, it is essential to check which type of detergent or all-in-one product best suits your needs! Read the detergent packaging carefully for information on proper use. Always follow the directions for use or information on the detergent packaging!</p> </div>
4. Buzzer volume	4:00 - 4:03	<p>The dishwasher uses a buzzer to indicate when a programme is finished or when a fault has occurred.</p>
5. Self-cleaning programme	5:00 (Off) 5:01 (On)	<p>Self-cleaning programme for antibacterial cleaning of the dishwasher tub, spray arms and spray pipes. This programme can be run (with no dishes in the machine) using normal dishwasher detergent, citric acid or one of the dishwasher cleaners available on the market. For the removal of limescale deposits see also the section Limescale deposits in the chapter Care and cleaning. Start the programme by activating the setting and then closing the door.</p>
6. ION	6:00 (Off) 6:01 (On)	<p>This setting prevents bad odours from dirty dishes left in the dishwasher. Activate the setting before starting a dishwashing programme. The fan and ioniser are activated at intervals for 72 hours. Do not use this setting in confined spaces with insufficient ventilation.</p> <div data-bbox="613 1066 1057 1219" style="border: 1px solid black; padding: 5px;"> <p>TIP!</p> <p>If you want to deactivate the ION setting to start a programme, open the door then press and hold the main power switch until the display turns off. Restart the dishwasher.</p> </div>
7. Water tank	7:00 (Off) 7:01 (On)	<p>Built-in water tank.</p>

Care and cleaning

Coarse filter

The coarse filter traps larger food particles, which cannot get past the drainage pump. Empty the coarse filter as necessary.

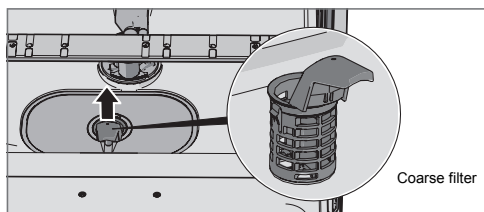

- 1 Lift the coarse filter by the handle.
- 2 Empty the coarse filter. Remember to replace it!

Fine filter

Debris that collects on the fine filter is automatically rinsed away during each wash. However, the fine filter and its pipe section should be cleaned a couple of times a year.

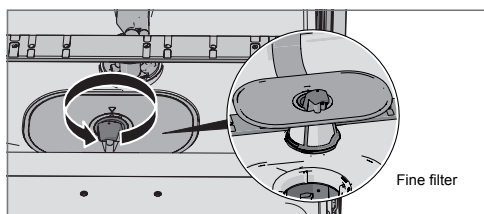

- 1 Turn the handle anticlockwise.
- 2 Lift the filter straight up using the handle. Free the coarse filter to clean the fine filter.
- 3 Replace in reverse order. Check that the edges seal properly when replacing the fine filter.
- 4 Lock the filter in place by turning the handle clockwise to the stop position. The handle should point straight out from the dishwasher.

NOTE!

The dishwasher must not be used without the filters in place!

Dishwashing results may be affected if the coarse filter is incorrectly fitted.

Drainage pump

The pump can be accessed from inside the dishwasher.

- 1 Cut the power to the dishwasher by pulling out the plug from the wall socket!
- 2 Remove the coarse filter and the fine filter.

- 3 In order to inspect the drainage pump, remove the coloured stop on the right in the bottom drain.
- 4 By inserting your finger into the hole you can turn the pump blade to release anything blocking it.
- 5 Replace the drainage pump stop along with the fine and coarse filters.
- 6 Plug the machine in again.

If the dishwasher still does not start and a whirring sound is heard, the overflow protection has been activated.

- Shut off the water.
- Remove the plug from the wall socket.
- Call the service department.

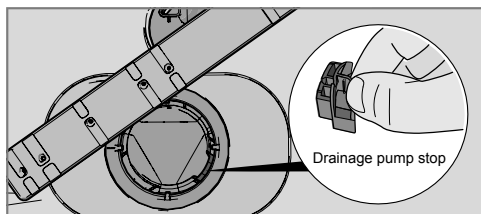

NOTE!

Do not forget to replace the drainage pump stop.

Spray arms

Holes and bearings can sometimes become blocked. Remove any debris using a pin or the like. The spray arms also have holes underneath.

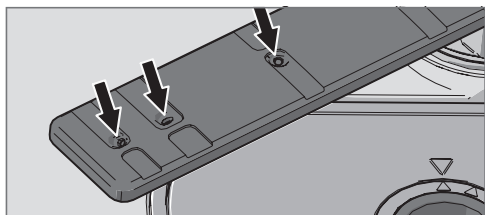

To facilitate cleaning you can remove the spray arms. Remember to fit them firmly back into place afterwards.

Lower spray arm

- Pull the lower spray arm straight up to release it.

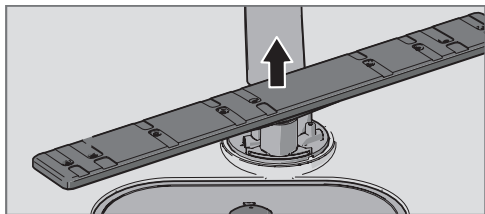

Upper spray arm

- 1 Pull out the upper basket.

- 2 Unscrew the spray arm bearings counterclockwise to remove the spray arm from the upper basket.

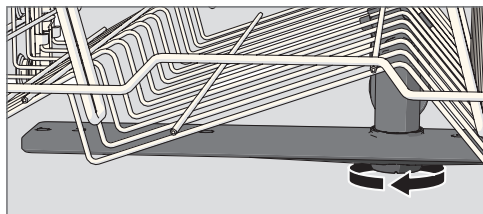

Door

When cleaning the edge around the door, use only a slightly damp cloth (with a little cleaner if necessary).

Limescale deposits

The dishwasher tub is made of stainless steel and is kept clean through normal use. If you have hard water, limescale deposits may build up in the dishwasher. If this happens, run a self-cleaning programme with two tablespoons of citric acid in the detergent compartment (with no dishes in the machine). The chapter Settings describes how to activate the Self-cleaning programme setting.

Front panel

Keep the buttons clean and free from grease. Wipe them clean with a dry or slightly damp cloth. Never use cleaners – they can scratch the surface. Use the main power switch to turn off the dishwasher before cleaning the buttons to avoid activating any buttons unintentionally.

Troubleshooting

Type of fault on the display		Action
F10	Overfilling	Clear the drainage pump. See the section Care and cleaning. If the problem persists, call the service department.
F11	Water Outlet Fault	See "Water remains in the dishwasher" in the table "Problem" below. If the problem persists, call the service department.
F12	Water Inlet Fault	Check that the water tap is on. Check that the outer filter on the inlet hose is not blocked. If the problem persists, call the service department.
F40	Inlet Valve Leakage	Turn off the water tap and call the service department.
F52	Water Level Fault	Check that the outer filter on the inlet hose is not blocked. If the problem persists, call the service department.
F54	Overfilling	Turn off the water tap and call the service department.
F56	Circulation Fault	Call the service department.

Press any button to clear the error message.

Problem	Possible causes	Action
The buttons do not react when pressed.	You have pressed the buttons too soon after opening the door.	Wait a moment then try again.
	The buttons are dirty.	Clean with a dry or slightly damp cloth.
	The door is closed.	Open the door. The buttons only react to use when the door is open.
Cannot close door.	The baskets are not correctly positioned.	Check that the baskets are correctly positioned horizontally.
		Check that the dishes are not blocking the baskets from sliding properly into place.
	The door lock does not click into place and lock.	Check the door lock. If it does not click into place and lock, open the door. Press and hold the button for the Auto open option for 15 seconds. Then wait 30 seconds. Close the door. Check that the door lock clicks into place and locks.

Problem	Possible causes	Action
The dishwasher does not start.	The door is not properly closed.	Check.
	You have opened the dishwasher to add more dishes while a programme is in progress.	Close the door and wait. After a while, the dishwasher continues the programme.
	The door lock has not clicked into place and locked.	Check the door lock. If it has not clicked into place and locked, open the door. Press and hold the button for the Auto open option for 15 seconds. Then wait 30 seconds. Close the door. Check that the door lock clicks into place and locks.
	A fuse/circuit breaker has been tripped.	Check.
	The plug is not plugged into the wall socket.	Check.
	The water tap is turned off.	Check.
	Overflow/leaks.	Check.
	A whirring sound (the drainage pump) is heard from the dishwasher and does not stop when the main power switch is turned off.	Turn off the water tap. Pull out the plug and call the service department.
	Check that the Delayed start option has not been selected.	Press and hold the main power switch until the display turns off if you want to cancel the Delayed start option. Restart the dishwasher.
The dishes are not clean.	The spray arms do not rotate.	Remove the arms and clean them. Check that the dishes are not blocking the spray arms.
	Old detergent. Detergent is a perishable product.	Avoid large packages.
	Incorrect detergent dosage.	Dose according to water hardness. Far too much or far too little detergent results in poorer dishwashing results.
	Dishwashing programme too weak.	Select a more powerful programme.
	Dishes loaded incorrectly.	Do not cover porcelain with large bowls or the like. Avoid placing very tall glasses in the corners of the baskets.
	Glasses and cups have toppled over during the programme.	Place dishes to sit steady.
	The filter is not correctly fitted.	Screw the filter firmly into place. See the section Care and cleaning.
Spots on stainless steel or silver.	Some foodstuffs, such as mustard, mayonnaise, lemon, vinegar, salt and dressings, can mark stainless steel if left for too long.	Rinse off these types of foodstuffs if not starting the dishwasher immediately. Why not use the Rinse programme.
	All stainless steel can cause spots on silver if they come into contact during dishwashing. Aluminium can also cause spots on dishes.	Silver and stainless steel items should not come into contact during dishwashing.

Problem	Possible causes	Action
Spots or films on the dishes.	The water softener is leaking salt.	Check that the salt compartment lid is properly tightened. Otherwise call the service department.
	Incorrect water softener setting.	See the section Settings.
	Incorrect rinse aid dosage setting.	See the sections Before washing for the first time and Settings.
	Salt compartment empty.	Top up with salt. See the section Before washing for the first time.
	3-in-1/ All-in-one detergent is used and the setting TAB (3-in-1/ All-in-one detergent) is activated.	Inactivate the setting TAB (3-in-1/ All-in-one detergent) and top up salt and rinse aid.
	Too high temperature and/or too much detergent can cause etching on crystal. Unfortunately, this cannot be repaired, only prevented.	Wash crystal at a low temperature and with a conservative amount of detergent. Contact the detergent manufacturer.
The dishes have a sticky white/blue film.	Rinse aid dosage setting too high.	Reduce the amount. See the sections Before washing for the first time and Settings. If you have very soft water, you may want to dilute the rinse aid 50:50 with water.
Spots left after washing.	Lipstick and tea can be difficult to wash off.	Use a detergent with a bleaching agent.
Rattling sound when dishwashing.	The dishes are not correctly placed or the spray arms are not rotating.	Check that the dishes are placed securely. Spin the spray arms to make sure they can rotate.
Sound from a fan is heard even when no dishwashing programme is running.	The ION setting is activated.	See the section Settings.
Water remains in the dishwasher.	Blocked drainage hose.	Loosen the drainage hose where it connects to the sink unit's water trap. Check that no debris has fastened. Is the cone-shaped part of the pipe cut to an inner diameter of at least 14 mm?
	Kink in drainage hose.	Check that the hose is free from kinks and sharp bends.
	The filters are blocked.	Clean the coarse and fine filters.
	Debris in the drainage pump.	Clean the drainage pump. See the section Care and cleaning.
Bad odour in dishwasher.	Dirt around the seals and in corners.	Clean with washing-up brush and low foaming cleaner.
	Low temperature programmes have been selected for a prolonged period.	Run a programme with a higher temperature about once a month.
	Dirty dishes have been left in the dishwasher for some time.	Activate the ION setting. See the chapter Settings.
	The dishwasher has not been used for a while.	Deactivate the Water tank setting. See the chapter Settings.

Problem	Possible causes	Action
Bad odour outside the dishwasher.	The ION setting is activated in a confined space with insufficient ventilation.	Deactivate the ION setting. See the chapter Settings.
The dishes are not dry enough.	The Auto open option is not activated.	Activate the Auto open option.
	The dishwasher is not fully loaded.	Fully load the dishwasher.
	Rinse aid needs topping up or dosage is set too low.	Top up with rinse add or increase the rinse aid dosage. See the sections Before washing for the first time and Settings.
	3-in-1/ All-in-one detergent is used and the setting TAB (3-in-1/ All-in-one detergent) is activated.	Inactivate the setting TAB (3-in-1/ All-in-one detergent) and top up salt and rinse aid.

Installation

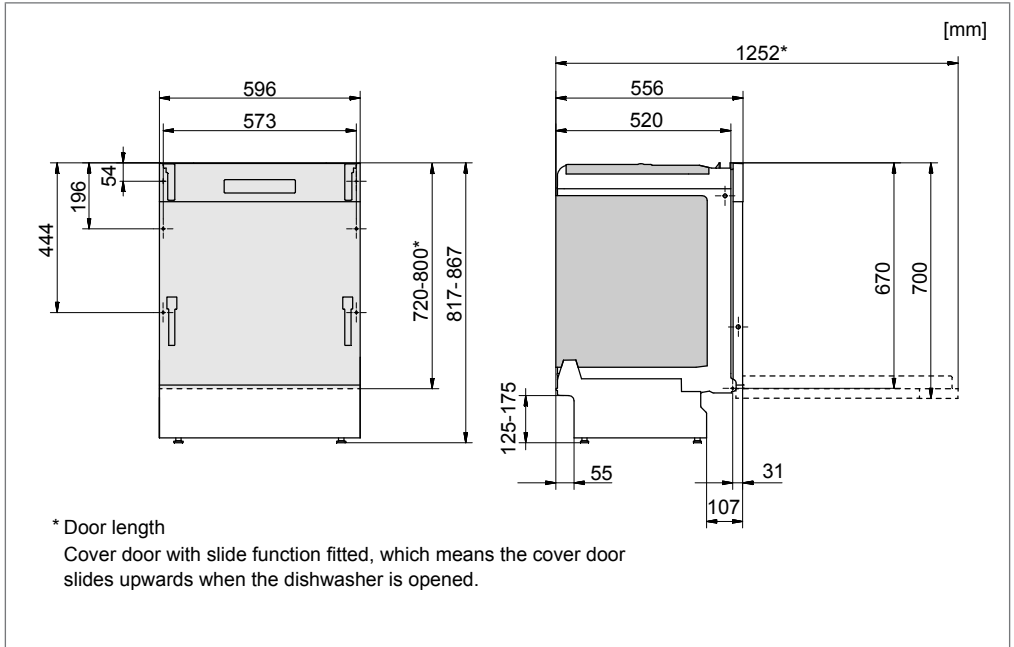

It is important that you read through and follow the instructions and directions below. Conduct installation and connection in accordance with the separate installation instructions.

Safety instructions

- Connections to electricity, water and drainage must be performed by a qualified professional.
- Always follow applicable regulations for water, drainage and electricity.
- Take care during installation! Wear protective gloves! There must always be two people!
- Place a watertight protective tray on the floor beneath the dishwasher to prevent damage from any water leaks.
- Before screwing the dishwasher into place, test the dishwasher by running the Rinse programme. Check that the dishwasher fills with water and drains. Check also that none of the connections leak.

⚠ WARNING!

Turn off the water supply when installing the dishwasher!

⚠ WARNING!

The plug must be disconnected or power to the socket turned off while the work is carried out!

Setup

- The recess and connection dimensions are included in the separate installation instructions. Check that all dimensions are correct before starting the installation. Note that the height of the cover door can be adjusted to match other fittings.
- Make sure the area on which the dishwasher is to be installed is firm. Adjust the adjustable feet so that the dishwasher is level.

Drainage connection

See the separate installation instructions for necessary information.

This dishwasher is suitable for installing in a raised recess (to attain an ergonomic working height). This means that the dishwasher can be placed so that the drainage hose runs to a lower level than the bottom of the dishwasher, such as by routing it directly to a floor drain. The dishwasher is fitted with an integrated anti-siphon device to prevent the machine from being emptied of water during the wash cycle.

The drainage hose can also be connected to a connection nipple on the sink unit's water trap. The connection nipple must have an internal diameter of at least 14 mm.

The drainage hose may be extended by a maximum of 3 m (the total length of the drainage hose must not exceed 4.5 m). Any joins and connecting pipes must have an internal diameter of at least 14 mm. However, the drainage hose should ideally be replaced with a new hose without joins.

No part of the drainage hose may be more than 950 mm above the bottom of the dishwasher.

Ensure that the drainage hose has no kinks.

Connection to water supply

Use only the supply hose provided with the dishwasher. Do not re-use old hoses or other spare supply hoses.

The supply pipe must be fitted with a stopcock. The stopcock must be easily accessible, so that the water can be shut off if the dishwasher has to be moved.

Once the installation is complete, the stopcock should be opened to allow the pressure to settle for a while and to check that all connections are tight.

Connect to cold water...

If you use oil or electricity to heat your home.

Connect to hot water (max. 70 °C)...

If you use district heating, solar power or geothermal power to heat your home. Choosing a hot water connection cuts programme times and reduces the dishwasher's electricity consumption.

Electrical connection

Information about the electrical connection can be found on the serial number plate. This specification must match the electricity supply.

The dishwasher must be connected to an earthed socket.

The electric wall socket must be placed outside of the installation area to be easily accessible after installing the dishwasher. Do not use an extension cord!

Read the chapter Troubleshooting before contacting the service department. Provide the details on the serial number plate in all contact. Include the article number (1) and the serial number (2).

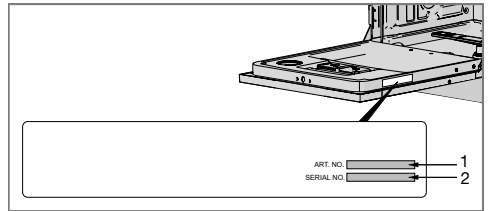

NOTE!

Repairs and maintenance relating to safety or performance must be carried out by a qualified professional.

Information for test institute

Request test institute information via e-mail dishwashers@appliance-development.com.

The request should include the details on the serial number plate. Include the article number (1) and the serial number (2).

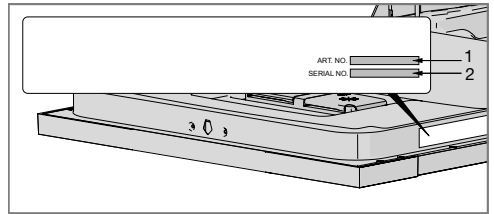

Information on energy labelling

Information sheet, in compliance with Commission Delegated Regulation (EU) No. 1059/2010

Gorenje

Model designation:	GV67260
Number of standard place settings:	16 ¹⁾
Energy efficiency class:	A+++
Annual energy consumption(AE _C):	245 kWh per year ²⁾
Energy consumption of the standard cleaning cycle(E _p):	0.86 kWh
Power consumption	
Off-mode (P _o):	0.49 W
Left-on mode (P _i):	0.49 W
Annual water consumption (AW _C):	1932 litres per year ³⁾
Drying efficiency class:	A ⁴⁾
Standard programme:	Eco wash ⁵⁾ , option Auto open
Programme time for the standard cleaning cycle:	180 minutes
Duration of the left-on mode (T _i):	Infinite
Noise emissions:	44 dB(A) re 1 pW
Construction:	Integrated product

- 1) *In accordance with standard, EN 50242.*
- 2) *Based on 280 standard cleaning cycles with a cold water connection and consumption in accordance with energy saving mode. The actual energy consumption depends on how the machine is used.*
- 3) *Based on 280 standard cleaning cycles. The actual water consumption depends on how the machine is used.*
- 4) *On a scale from G (least efficient) to A (most efficient).*
- 5) *This dishwashing programme is the standard cleaning cycle used to compile the energy labelling information. It is intended for washing normally dirty dishes and is the most effective programme in terms of combined energy and water consumption.*

Technical data

Height:	817-867 mm
Width:	596 mm
Depth:	556 mm
Water pressure:	0.03–1.0 MPa
Electrical connection:	See serial number plate
Rated power:	See serial number plate



en (10-16)