

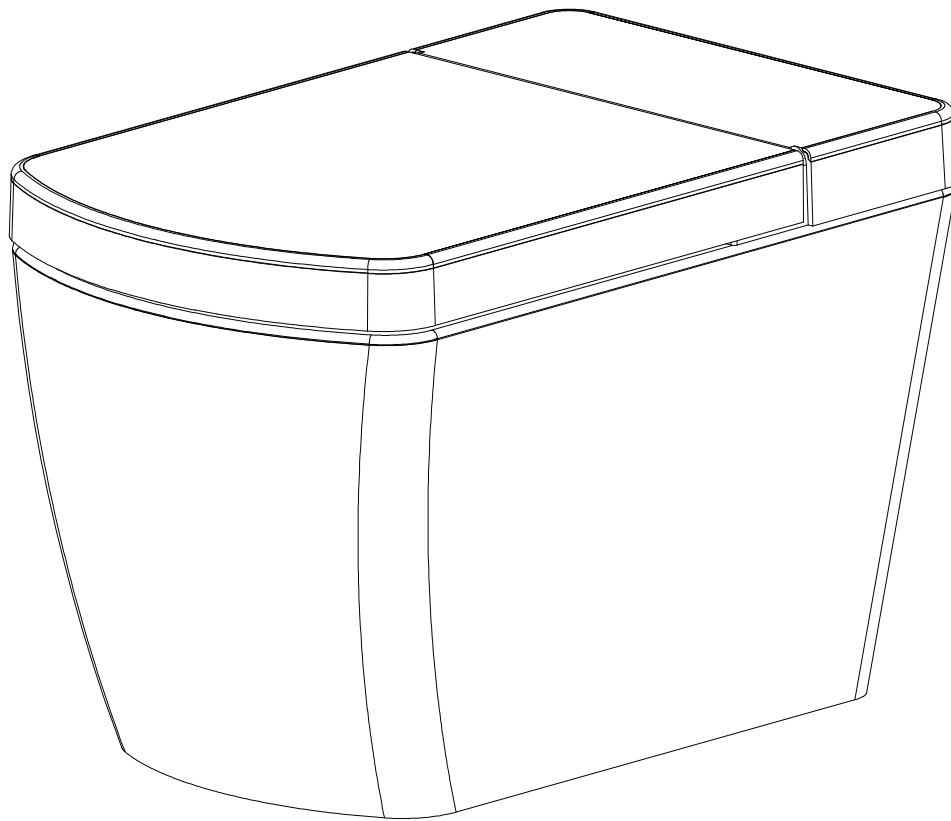

Installation Instruction



High-end Intelligent Toilet
OPERATION INSTRUCTIONS

Directory





OPERATIOG INSTRUCTIONS





Safety Precaution	01
Application Notice	04
Function Description	05
Names Of Parts And Channel Setting	06
Remote Function	07
Installation Instruction	11
Confirmation Before Using	12
Maintenance Instruction	13
Troubleshooting	14
Check And Accept	16
Specification	17
Packing List	18
Product Model	19

Safety Precaution ——— Warning





Please read the manual carefully before using the product properly. Please keep the instruction manual after reading.
 When a person who has a physical or mental disability or a lack of experience and common sense, including children, must be used under the guidance of a normal person. Children can not play with the machine. The following notices are very important to comply with.

● Signs explanation





 Warning	Do not fail to comply with the regulations. Risk of the personal injury or death.
 Caution	Do not fail to comply with the regulations. Risk of the personal injury or property damage.
 Prohibition	Danger tips, please strictly comply with, otherwise cause casualties.
 Compulsion	Must comply with the tips.

 Warning	
 Prohibition disassemblage	Absolute prohibition of removal, repair, alteration of this product. ● Risk of fire, electric shock or other accidents.
 Prohibition watering	Do not pour water or detergent to the product or on the power plug. ● Risk of fire, electric shock or other accident.
 Compulsion	Do not use the product if the toilet failure, Please contact service provider to repair. ● If there are faults as follow, please switch off power and close valve. 1. leak from pipe or interior 2.temperature abnormally high. 3.unusual noise and smell. 4.fuming.
	● Do not use the product if it doesn't work. if fail to comply with it, may cause fire, electric shock, and watering in the room. Please contact the service provider.
	Do not use other water except tap water. ● Risk of dermatitis and other issues.





Safety Precaution ——— Warning ———

 Warning	
 Prohibition	<p>Do not use loose and unstable power outlet. ●Risk of fire,electric shock or other accidents.</p>
	<p>Please use the specific(220V~240V,10A,50Hz-60Hz)power outlet. Do not use other power except AC 220V~240V. When you use a power exceeding outlet provides, may cause heat even fire.</p>
	<p>Do not destroy power supply line and connecting line. 1.Do not damage,process,heat 2.Do not force bent, volume binding, pull 3.Do not place heavy objects on the power line or connecting line. If ignore the damage,andcontinue to make it work,may cause fire,electric shock,short circuit and other accidents.</p>
 Compulsion	<p>(1)Do not splashed on the product or put it in excessive moisture place. When bathing in the wash room, please keep fresh by ventilation fans or ventilation ports.(Risk of fire or electric shock) (2)This product must be grounded.(Risk of electric shock) (3)Make sure power plug connect only to a dedicated power outlet(220V~240V,10A,50Hz-60Hz).(Risk of fire or electric shock) (4)If the power line is damaged, please don't remove by yourself. It must be finished by manufacturer, or the professionals. (5)The new hose–sets supplied with appliance are to be used and that old hose–sets should not be reused.</p>
	<p>If sit on the seat of long time,please keep the seat under low temperature,so that not cause ambustion. Please keep the temperature in low for the following persons: ● Children,the olds who can't adjust the temperature to appropriate by themselves. ● Patient、 disabled who can't move freely. ● The sleepy persons because of taking hypnotics (such as sleeping pills,cold medicine),drink heavily,excessive fatigue</p>
 Grounded	<p>Please make sure if it is grounded. If fail to be grounded, may cause fault or electric shock.</p>

Safety Precaution — Warning

 Warning	
 Safety Precaution	<p>Do not approach to product with open fire. ● Risk of fire.</p>
 Prohibition	<p>Do not place heavy objects or stand on the cover of the toilet, also not impact product. If the product is broken, may cause personal injury or watering in the room.</p>
	<p>Do not put or block the wind outlet with fingers or other items. ● Risk of burn, electric shock or accessories damaged.</p>
 Observation	<p>Do not make hose bend, damaged. ● Risk of leakage. Cleaning with kitchen abluent (neutral). Do not use following items: Toilet detergent, housing detergent, propellant, banana oil etc. Risk of plastic parts damaged, even personal injury if broken. ● Risk of leakage if hose damaged. Do not flush other stuff except shit, pee and toilet paper. ● Risk of toilet-clogging, sewage spills. Do not remove filter if the valve is open. ● Risk of spraying water.</p>
	<p>Please fix the valve tightly. ● Risk of leakage.</p>
	<p>When leaking, please close the valve.</p>
	<p>Prevent injury due to freezing. ● Risk of leakage because freezing will cause hose or interior damage.</p>

Safety Precaution Warning

 Warning	
 Observation	<ul style="list-style-type: none"> ● Tap water pressure must be between 0.15MPa-0.75MPa. <p>After installation,make the power supply plug connect to power outlet,If the LED indicator lamp lights,the product is powered on.</p>
 Observation	<ul style="list-style-type: none"> ● Avoid exposing to the straight sunlight. May cause the product change color,and not work normally. ● Do not make pee on the main parts or nozzle. May cause fault. ● Do not lean on cover. May cause cover damage. ● When electrical storm, please disconnect the power plug and power outlet. May cause fault. ● When does not use for long time, please turn off the water and power. ● In daily,please avoid splashing water to the product. May cause water into the interior,and damage.
 Observation	<ul style="list-style-type: none"> ● Keep the remote control away from water. May cause the water enter to the interior, and damage. Please take care of it ● After remote control used for long time, please replace the battery if the signal received weakly because of battery energy exhausts.
 Observation	<ul style="list-style-type: none"> ● Avoid stuck of the track of the cover or seat when opening or closing it. May cause fault. ● Do not seat on the cover when the cover is closed and open. May cause fault.

Function Description — Integrated toilet

I CLEANING

1. **Rear soft** Soft but satisfying water stream with specially designed built-in aerated pump, cleaning hip deep dirt.
2. **Female Cleaning** Soft aerated mist water stream for feminine cleaning.
3. **Reciprocating cleaning** Clean Nozzle automatically moves back and forth with soft water stream for wide cleaning.
4. **Nozzle position adjusting** Cleaning the best place with adjusting nozzle back and forth.
5. **Massage** Water pressure changes from strong to weak circularly to help avoiding any constipation.
6. **Water pressure adjusting** Five levels pressure to adjust to make sure the cleaning force suitable for you.

II HUMANISTIC SERVICE FUNCTION

1. **Without tank** Connect the water supply tube directly. Avoid germ and smell in the tank. Supply warm water continually with instant heating system.
2. **Auto flush** When leave seat, toilet start autoflush.
3. **Auto opening cover and seat** Auto opening the cover with human sensor, and open the seat with remote control, safe and convenient.
4. **Drying** After cleaning the drying function free yourself from toilet roll.
5. **Temperature adjusting** 5 levels temperature can adjust for seat, wind and cleaning water.
6. **Auto deodorization** Active carbonated deodorizer eliminates embarrassing odor.
7. **Wireless remote control** Remote control with RF technology.
8. **Self-cleaning nozzle** The nozzle will clean itself before Rear soft or Female cleaning.
9. **Warm seat** Warm seat makes you comfortable in winter.
10. **Night light function** When the cover open, the night light will turn on, it will turn off after you leave for 5 min.

Names Of Parts And Channel Setting — Integrated toilet —

- One model for example

Tip. When you have multiple smart toilets, set them to different channels for remote control.

Setting channel steps:

1. Please plug in the toilet
2. Press the STOP button on the toilet panel, hold down the button.
3. Meanwhile press MALE CLEANING button to change the channel
4. There are 8 channels for you to choose, you can hear different beep on different channels. Choose one of them.
5. Take out the remote control, hold down the two buttons “+” “-” until hearing the beep, release the buttons immediately. Channel setting is complete.

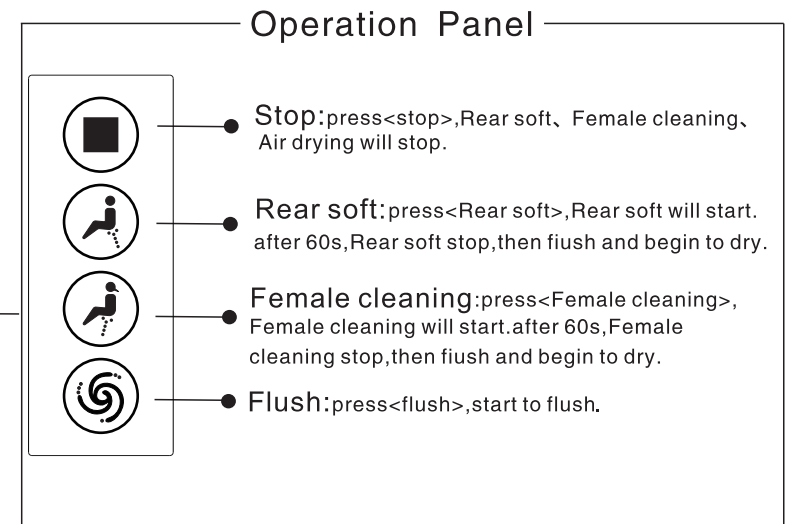
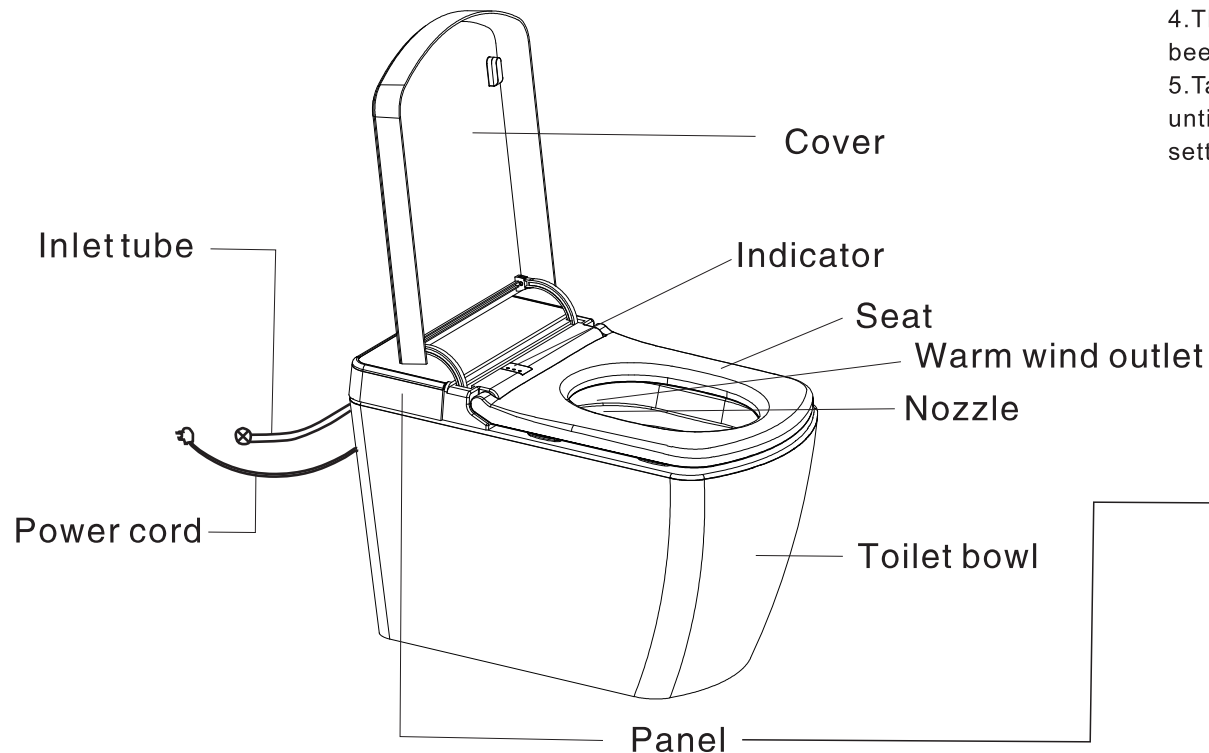

Notice: Appearance and function in kind prevail

Remote Function — Function Details

Notice: Appearance and function in kind prevail

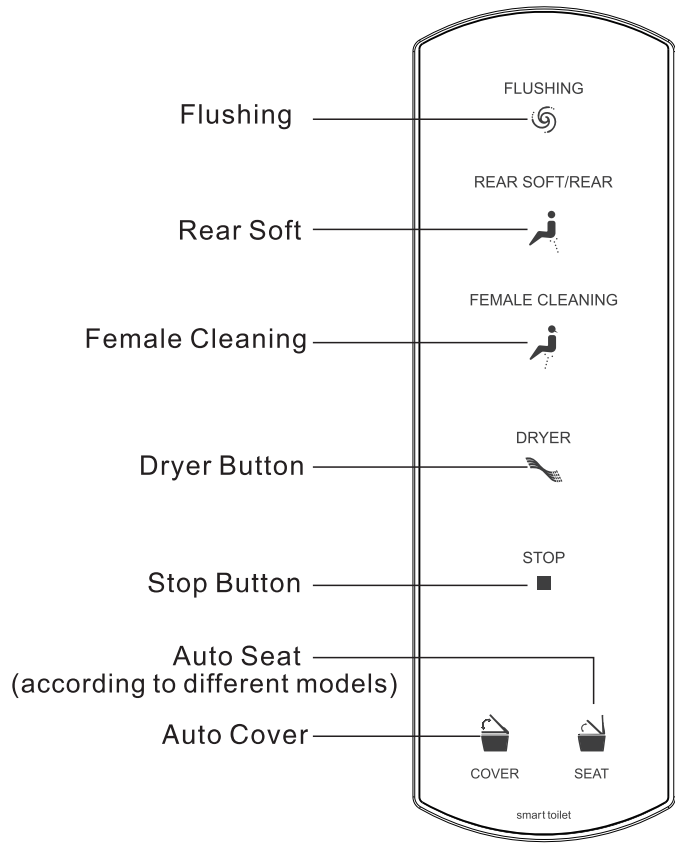

Remote control front

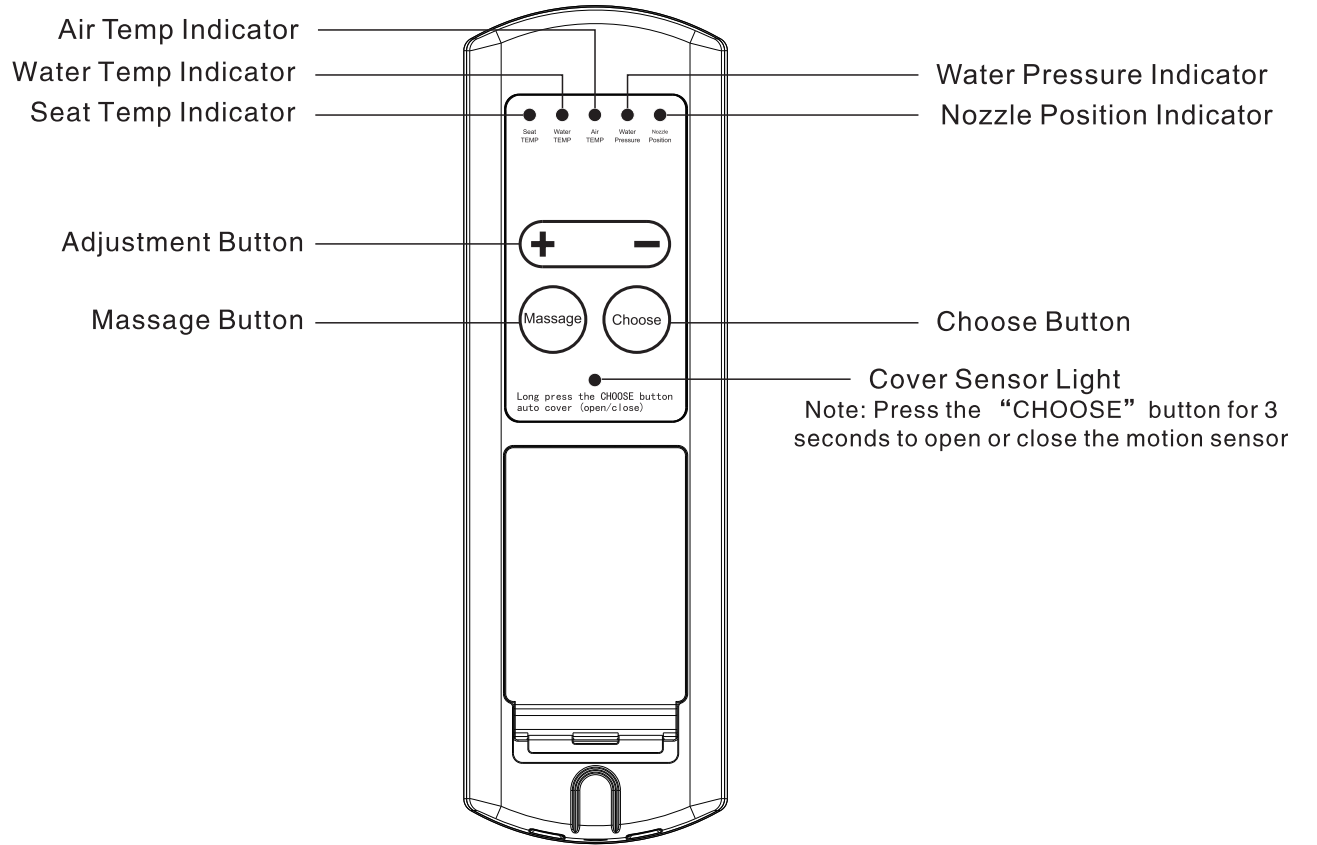

Remote control back

Remote Function — Function Details

I Flushing

Press FLUSH button on the remote, flushing works. When the power cut, you can press flush on the operation panel to flush; when the seat sense, the water will wet the ceramic and , it will flush automatically after you leave.

II Rear Soft

When the seat sense, press Rear soft once to start work; press twice to start reciprocating, Nozzle automatically moves back and forth with soft water, press again to stop.

III Female Cleaning

When the seat sense, press Female cleaning once to start work; press twice to start reciprocating , Nozzle automatically moves back and forth with soft water, press again to stop.

IV Dry

Press DRYING to start working. Warm wind will dry your skin.

V Auto Cover

When you get in the rang of cover sensor, the cover will open automatically. After you leaving for 5 min the cover will close (Cover sensor only works as you moves, if you stay still, it can't sense you.) You can open or close the cover with button COVER also.

Remote Control Function — Function Details

VI Remote Control Seat

You can open or close the seat with button SEAT(according to different models).

VII Massage

When Rear soft or Female cleaning is working, press Massage to start work, the water pressure begins to change from strong to weak circularly, press again to stop.

VIII Adjustment

Press CHOOSE button, the indicator light will lighten, choose the function you want to adjust, then press ‘Adjust +、-’ to change the levels. There are five levels to choose. The red light represents the highest level and green means the lowest. You can press button continually and the light will lighten in turns.

IX Motion Sensor on/off

Press CHOOSE button for 3 seconds to open or close the cover sensor. The red light means close and the green means open.

X App Function

Download “smart toilet” on App Store and use Bluetooth to connect the toilet.

Installation Instruction ——— Integrated toilet ———

I Preparation

Tools and materials required(not supplied): Adjustable wrench、carpenters level、Blade screwdriver、silicon sealant、glass cement、Masking tape、Band tape、square、drill、assorted bits.

II Installation

- Install toilet

Fix the flange on the bottom,connect the toilet with flange to the Drain pipe on the floor, and put down slowly. Attach silicon sealant on the bottom edge of the toilet.

Install shutoff Valve

- A、Close the main water supply.
- B、Wind Teflon tape around connecting thread of shutoff valve.
- C、Connect the adapter and shutoff Valve,tighten up with wrench.
- D、Connect the constant perssure valve.

After install the shutoff valve,open it for 30s so that make sure all the rust and the other impurities can be flushed out from the pipe,in the meantime, check the leakage.

Notes: Please find professional person to install the toilet. After installation, please check it carefully. After 48 hours silicon sealant is soild completely.

Installation Instruction ——— Integrated toilet

III Structure

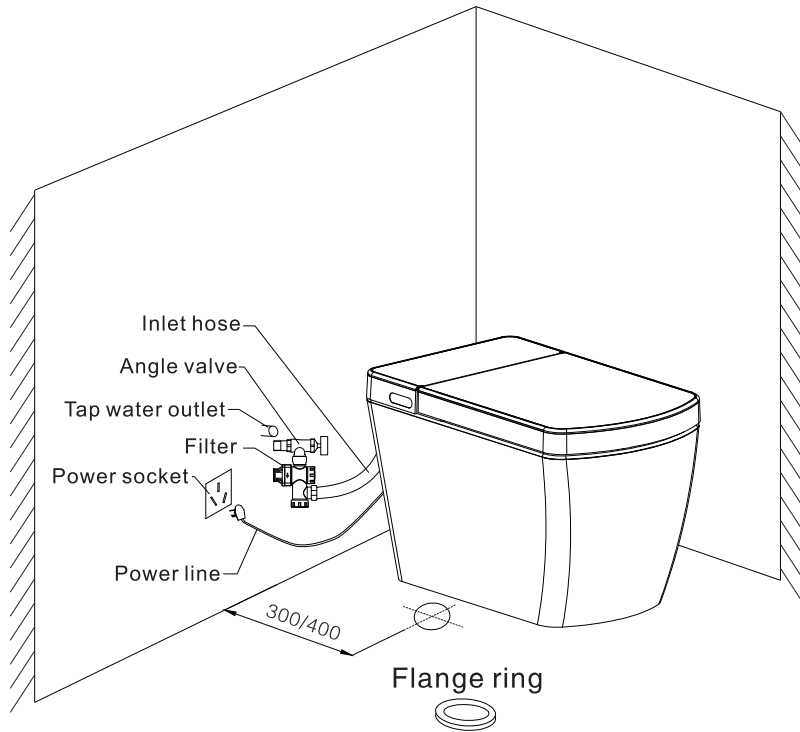

Note: According to different models

IV Install controller

1. Stick the holder to the wall with tape.
2. Put the controller into the holder.

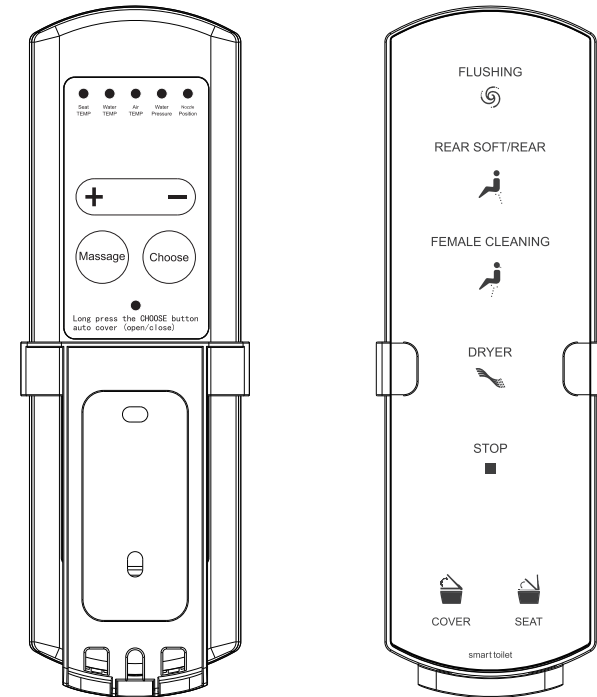

3M tape behind

Confirmation Before Using — Integrated toilet

I Install battery

Put two batteries into remote control properly.

Note: To avoid battery broken、leakage, please make sure comply following tips.

- Please replace the same specification battery.
- Please take out battery when not use for long time.
- Please note the polar when replace battery.
- All setting information(temperature, level etc)will cleared and resort to factory setting after replace battery.

II Connect power

Connect the power plug to power outlet, the product will set up automatically, finish set-up in 10 seconds.

III Connect water

Open inlet valve, make sure water run well.

IV Check indicator light

Check indicator light if it is lighten. If not, check the power .

Maintenance Instruction — Integrated toilet

Please clean and maintain product as follows

- Clean with soft wet cloth.
- If necessary, clean with neutral detergent, then with water.
- After clean ceramic, please dry the detergent residue on the plastic with soft cloth.
- To avoid water, please dry with soft cloth after cleaning because it is electric product.

Clean filter net (one time every month)

1. Close water inlet valve.
2. Remove off the filter net.
3. Clean

Clean up the sewage on the filter with water;

Clean up sewage piece with brush.

4. Install filter

Install back the filter, and make sure tighten well. If not, may cause leakage.

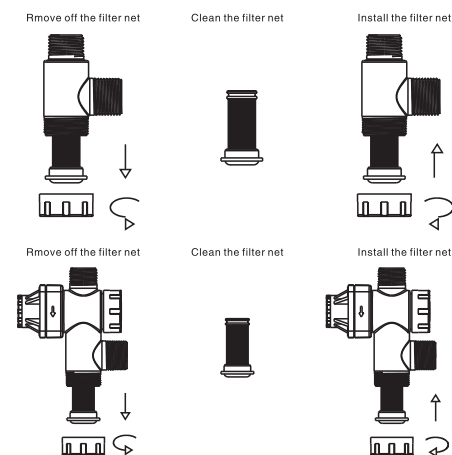

Troubleshooting ——— Integrated toilet ———

⚠ Note: Do not disassemble and repair by yourself, please get help from professional person(May cause fire or electric shock). Please refer to the troubleshooting guide if it doesn't work. If can't solve please contact in time with your dealer or wholesale distributor.

Product part or function	Symptoms	Probable Cause	Recorrective action
Main part	Does not work	The power is not switched on	Open power
		The power cord is disconnected or the plug has no power	Insert the power cord into an electrical outlet or check the power plug
		A power failure occurred	Wait until the power is restored
Rear soft, Female cleaning	The nozzle has no water out	The water supply valve is closed	Turn on water valve
		Water failure occurred	Wait until water is restored
		The nozzle plugged	Clean the nozzle according to the installatio guide
	The water pressure is low	Seat doesn't detect user	Adjust the sitting position
		Low supply pressure	Increase the pressure
		The water supply is clogged	Clean the filter

Troubleshooting ——— Integrated toilet

Product part or function	Symptoms	Probable Cause	Recorreective action
Rear soft, Female cleaning	Water stops flowing from the spray wand before toilet finished cleansing	One minute after pressing one of the spray icons, washing automatically stops.	Press the "Rear soft" or "Female cleaning" again
		User is not detected by seat sensor	Adjust the sitting position
	The water temperature is low	Heating function not start	Increase the water temperature
Air Dryer	The wind temperature is low	Heating function not start	Increase the wind temperature
	The dry fansion stop during use	One minute after pressing "drying" icon, blower automatically stops.	Press the "drying" icon again
		User is not detected by seat sensor	Adjust the sitting position
Seat Heated	The seat temperature is low	Heating function not start	Increase the seat temperature
		energy saving	Reset seat temperature
Buzzle abnormal alarm	Indicator light of water temperature flash	Cut off the power, and switch on again. If still have problems, cut off power and contact your dealer maintenance agency.	
	Indicator light of seat temperature flash		
	All indicator light flash	Cut off the power, check if the water supply is stopped. Wait until water is resorted. Turn on power.	
	Leakage	Close shut off valve, stop water supply. Check if the water supply pipe is broken, contact your dealer or maintenance agency.	

Check And Accept _____ Integrated toilet _____

After installation, must test before the first use. And make record.

Checking				Results
The power outlet is must be 220V ~240V				
Connect power well, not loosen				
Water supply is opened				
Each connections is tightened, reliable (such as valve, filter)				
Power indicator light lit				
Nozzle is no leakage				
<p>All function can work normally. Check and make sure all functions, Rear soft, Female cleaning (massage, oscillating, water pressure, move), air dryer temperature, water temperature, seat temperature, flush automatically, remote control, screen, and indicator lights works well.</p>				
Installation Date		Installation Shop		Installation Worker

Specification ——— Integrated toilet ———

Item		Description
Electrical power		220V ~ 240V
Rated Frequency		50Hz-60Hz
Power cord length		1.5M
Rated power		1150W (when income water temperature at 15℃, cleaning water temperature the highest, cleaning flow the largest, seat temperature the highest)
Water supply pressure		0.15MPa-0.75MPa (1.5-7.5 Bar) and more than 0.32L/S
Cleaning unit	Water for rear soft	Water pressure is 0.2MPa(flow)about0.5-0.9L/min(5 levels)
	Water for female cleaning	
	Water pressure	5 level adjusted(rear soft and female cleaning)computer controlled
	Water temperature	5 level adjusted
	Heating power	1600W
	Safety protection devices	Temperature sensor , temperature fuse wire , water temperature sensor , flow controller
Seat	Seat heating power	45W
	Soft close	Slow down when open and close
	Seat temperature	5 level adjusted
	Safety protection devices	Temperature control switch, temperature fushing silk
Dry	Wind heating power	270W
	wind temperature	5 level adjusted
	Safety protection devices	Temperature control switch, temperature fushing silk
Flush way		Siphon jet flush
Operation environment		0-40℃

Packing List — Integrated toilet

If water pressure is under 0.15 MPa. may cause work abnormally.

Number	1	2	3	4	5	6
Name	Integrated toilet	Remote	Instruction Certificate card Warranty card	Valve	Filter	Sewage pipe/ Flange
Quantity	One	One	One	One	One	One
Remark				According to different models	According to different models	According to different models

Our company reserves the right of final interpretation. We reserve the right to make changes in product characteristics, packaging or availability at any time without notice.

Product Model — Integrated toilet

	Product function
Cover sensing	√
Male Cleansing	√
Female Cleansing	√
Stretch- drying	√
Internal drying	○
Warm seat	√
Warm water washing	√
Reciprocating cleaning	√
Tube position adjusting	√
Massage	√
Cleaning pressure adjusting	√
Water Temp adjusting	√
Wind Temp adjusting	√
Seat Temp adjusting	√
Self-cleaning nozzle	√
Automatic deodorization	√
Manual flushing	√
Automatic flushing	√
Soft close	√
Remote control cover	√
Remote control seat	√
Night lamp	√
App Function	√

Note: “√” have this function , “○” without this function, “△” optional function, some models' Tube position is adjustable with 4 level.

www.hafelathailand.com